

SOHNNE®

ASSEMBLY INSTRUCTION

Rivenn Leather Recliner & Ottoman











Welcome Guide

www.sohnne.com

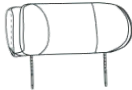

In the Box

Your Rivenn arrives in two boxes. Lay out every component and fastener before you start — you'll only need the two Allen wrenches provided.

Box 1 :

B1×1  Chair Body	B2×1  Ottoman Body	C1×1  Headrest
H1×4  Bolt (M6x25mm)	H2×4  Spring Washer (M6)	H3×4  Flat Washer (M6)
H4×4  Bolt (M6x25mm)	T1×1  5mm Allen Wrench (M5)	T2×1  4mm Allen Wrench (M4)

Box 2 :

A1×1 (Large)  Chair Base	A2×1 (Small)  Ottoman Base	
---	---	--



ONCE ASSEMBLED

A reclining lounge chair with a height-adjustable headrest, paired with a matching ottoman on a polished steel swivel base.

1 Attach the Chair Base (A1)

Fix the Chair Base (A1) to the underside of the Chair Body (B1) using the four Bolts (H1), Spring Washers (H2), Flat Washers (H3) and the M5 Allen Wrench (T1). Mind the orientation: the higher end of the metal plate on A1 must face the front of the chair, the lower end the back. Do not use power tools.

2 Insert the Headrest (C1)

Stand the chair upright on its base. Line the two prongs of the Headrest (C1) up with the openings at the top of the Chair Body (B1) and press it firmly straight down until it seats securely.

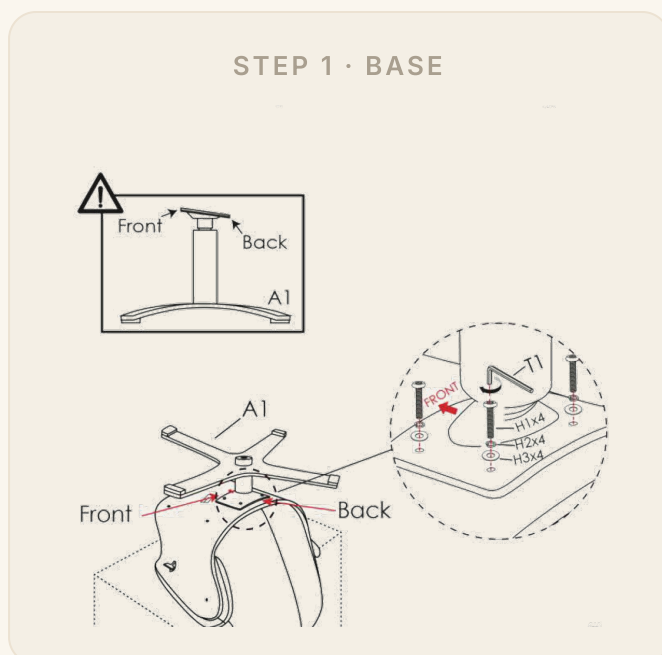

3

Attach the Ottoman Base (A2)

Place the Ottoman Body (B2) upside-down on a soft, clean surface to protect the upholstery. Fit the Ottoman Base (A2) to its underside and secure it with the four Bolts (H4), tightening each with the M4 Allen Wrench (T2).

4

Stand upright & final check

Turn both the chair and ottoman upright. Go over every bolt to confirm it is fully tightened and that both pieces sit level and stable. Assembly complete — enjoy your Rivenn.

STEP 3 · OTTOMAN BASE

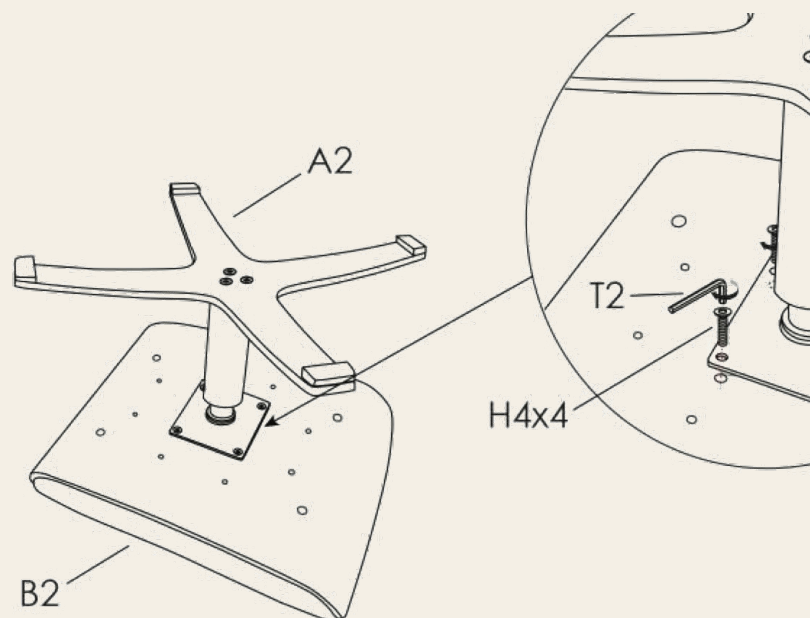

Adjustments



Headrest height

Lift or lower the headrest to suit your height.



Headrest angle

Three forward positions. From Position 0 (original), push it forward in stages to reach Positions 1 and 2. To reset, push further to Position 3 — it then releases back to Position 0.



Backrest recline

Lift the side latch and lean back to recline. To return upright, sit up slightly and lift the latch — the backrest moves forward to the upright position.

HEADREST HEIGHT



HEADREST ANGLE

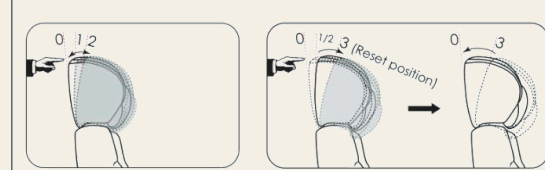

BACKREST RECLINE

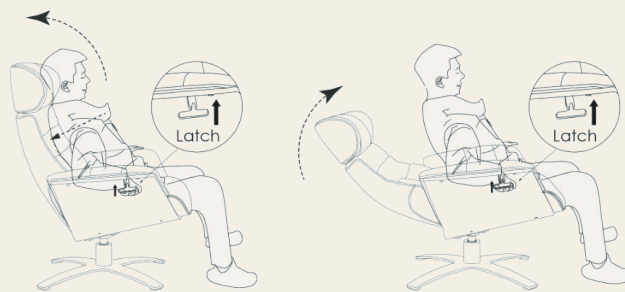

CARE & MAINTENANCE

Wipe leather with a soft, dry cloth; avoid direct sunlight and heat sources.

Periodically re-check the base bolts. Backed by a 12-month manufacturer warranty and 24/7 customer care.

SOHNNE®

@sohnne

SHARE · REVIEW · EARN

Worth sharing.

\$100

FOR A VIDEO REVIEW

\$50

FOR A PHOTO REVIEW

 Tag us @sohnne

www.sohnne.com