

SOHNNE®

ASSEMBLY INSTRUCTION

# Shell 07 Chair



# Welcome Guide

[www.sohnne.com](http://www.sohnne.com)

# In the Box

Unpack and identify every part before you begin. You'll need only the included hex key — no power tools.

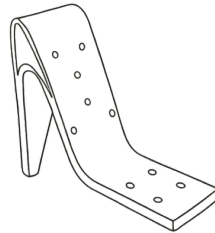
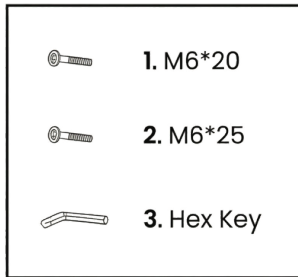

A. Back Leg

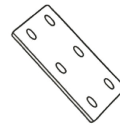

B. Bracket

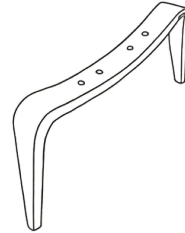

C. Front Leg

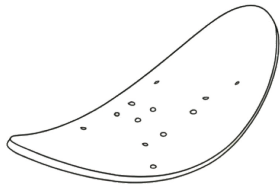

A. Seat Board

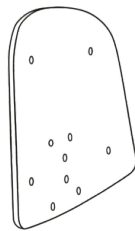

B. Back Board

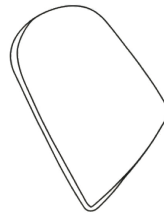

B. Back Cushion

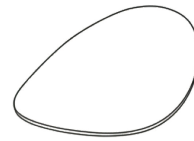

C. Seat Cushion

**BOX CONTENTS**  
1 × Shell 07 Chair

**MAX LOAD**  
100 kg (220 lb)

**WARRANTY**  
12-month manufacturer

**SUPPORT**  
24/7 customer care

## 1 Join the legs

Attach the front legs and the back leg to the brackets with 6 × M6×20 screws. Keep them loose for now — they're tightened fully in a later step.

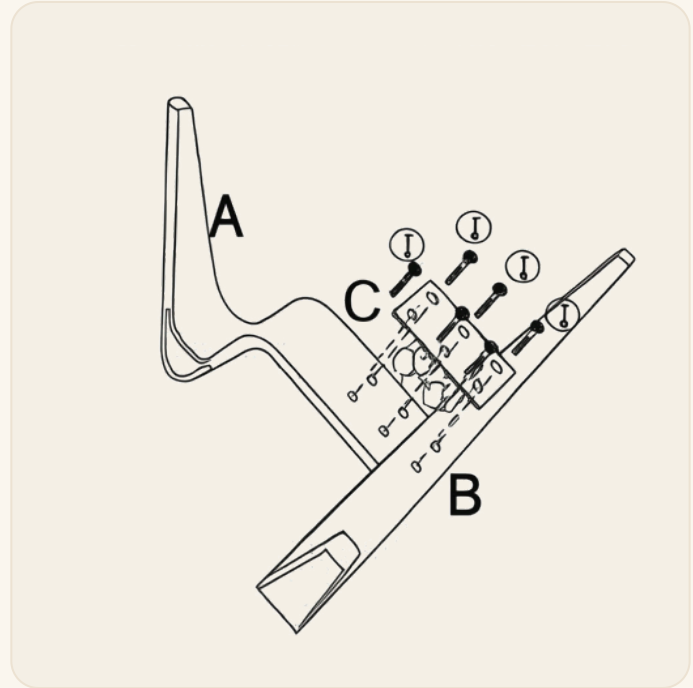

## 2 Fit the seat board

Fasten the seat board to the front and back legs with 8 × M6×20 screws. Don't fully tighten until the last screw is started.

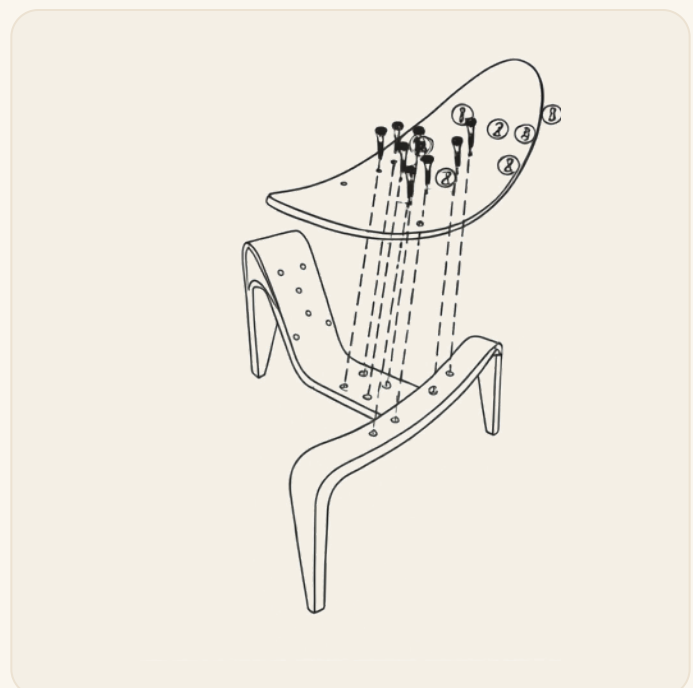



5

## Mount the back cushion

Fix the back cushion to the back board with 4 × M6×20 screws.

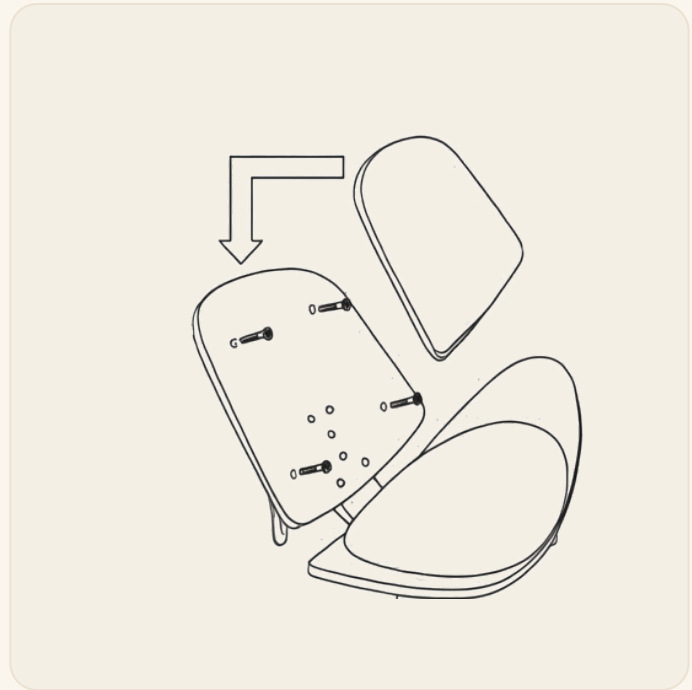

## All done

Work around the chair and give every screw a final, even tightening. Then settle in and enjoy your Shell 07 Chair.



SOHNNE®

@sohnne

SHARE · REVIEW · EARN

# Worth sharing.

\$100

FOR A VIDEO REVIEW

\$50

FOR A PHOTO REVIEW

 Tag us @sohnne

[www.sohnne.com](http://www.sohnne.com)